

Data Collector TR-57DCi

User's Manual

Thank you for purchasing our product.
This manual provides a brief explanation of
how to set up and get started with the
TR-57DCi.



Safety Precautions and Instructions

Important Notices and Disclaimers

In order to properly use this product, please carefully read this manual before using. T&D Corporation accepts no responsibility for any malfunction of and/or trouble with this product or with your computer that is caused by the improper handling of this product and will deem such trouble or malfunction as falling outside the conditions for free repair outlined in the attached warranty.



- All rights of this User's Manual belong to T&D Corporation. It is prohibited to use, duplicate and/or arrange a part or whole of this User's Manual without the permission of T&D Corporation.
- Microsoft and Windows are registered trademarks of Microsoft Corporation in the United States and/or other countries.
- All registered trademarks, company names, product names and logos mentioned herein are the property of T&D Corporation or of their respective owners.
- Specifications, design and other contents outlined in this manual are subject to change without notice.
- Please follow the safety precautions outlined in this manual carefully. We cannot guarantee nor are we responsible for safety if this product is used in any manner other than was intended.
- On screen messages in this manual may vary slightly from the actual messages.
- Please notify the shop where you purchased this product or T&D Corporation of any mistakes, errors or unclear explanations in this manual. T&D Corporation accepts no responsibility for any damage or loss of income caused by the use of our product.
- This product has been designed for private or industrial use only. It is not for use in situations where strict safety precautions are necessary such as in connection with medical equipment, whether directly or indirectly.
- We are not responsible for any malfunction or trouble caused by the use of our product or by any problem caused by the use of measurement results of our unit. Please be fully aware of this before using our product.
- This User's Manual cannot be reissued, so please keep it in a safe place.
- Please read the warranty and provisions for free repair carefully.

To ensure safety obey all of the following warnings.







The following items should be strictly obeyed for the safe usage of the TR-57DCi Unit, (hereinafter referred to as this/the "Unit") , and for protecting yourself and other people from bodily harm and/or damage to property. Before using this Unit, please read the following carefully and fully understand the contents.

Explanation of Symbols

Explanation of Warning Symbols

 DANGER	DANGER: These entries are actions that absolutely under no circumstance should be taken. The taking of such an action may cause serious personal physical damage or death.
 CAUTION	These entries are actions that if taken may lead to physical injury or damage to persons or things.

Explanation of Picture Symbols

	Denotes an important warning or caution. Specific warning message is indicated by the symbol. (EX:  Caution against electric shock)
	Denotes a forbidden action. Specific forbidden matter is indicated inside or by the symbol. (EX:  Do not disassemble)
	Denotes an action that must be taken. Specific instruction is indicated inside or by the symbol. (EX:  Unplug power plug from outlet)

⚠ DANGER



When installing and using this Unit, make sure to follow all warnings and directions from your computer manufacturer.

Strictly Follow



Do not take apart, repair or modify the Unit. Doing so may cause fire or electrocution.

Do Not
Disassemble



If water or a foreign object enters into the Unit, immediately turn OFF the power, remove batteries, and stop using. Continued use may cause fire or electrocution.

Strictly Follow



Do not use this Unit in wet or humid places, such as a bathroom. Doing so may cause fire, electrocution, and/or malfunction.

Forbidden



Store the TR-57DCi Unit, batteries and communication cables out of the reach of children. Touching them may cause injury and swallowing batteries is extremely dangerous.

Strictly Follow



Do not connect communication cables for the Unit to telephone line outlets. Continued use may cause fire or electrocution.

Forbidden



If any smoke or strange smells are emitted from the Unit, immediately turn OFF the power, remove batteries, and stop using. Continued use may cause fire or electrocution.

Forbidden



Do not drop or expose the Unit to a strong impact. If that happens to the Unit, immediately turn OFF the power, remove batteries, and stop using. Continued use may cause fire or electrocution.

Forbidden

⚠ CAUTION



This Unit is not waterproof. If the Unit gets dirty, wipe it with a clean cloth and a mild detergent.

Strictly Follow



Do not put fingers or foreign objects into the communication cable jack.

Forbidden



CAUTION

Battery life varies depending upon the type of battery, the measuring environment, frequency of communication, ambient temperature in which it is used, and battery performance.



Do not use any other batteries than those that are specified in this Manual. It may cause fire or malfunction.

Forbidden



Do not use AC adaptors other than those specified for use with the Unit. Doing so may cause fire or malfunction.

Forbidden



Strictly Follow

If the Unit is not to be used for a long period of time, for safety reasons please remove the batteries. Leaving batteries inside the Unit may cause battery leakage and malfunction.



CAUTION

Battery terminals may provide insufficient contact due to age or vibration. This may lead to data loss.



Strictly Follow

Condensation may occur if the Unit is moved from one environment to another where the difference in temperature is great. Use this Unit in an environment where the ambient temperature is from 0 to 50 and the humidity is 90%RH (no condensation) or less.

Compliance Information

This device complies with Part 15 of the Federal Communications Commission (FCC) rules. Operation is subject to the following two conditions: (1) This device may not cause harmful interference, and (2) this device must accept any interference received, including interference that may cause undesired operation.

This equipment has been tested and found to comply with the limits for a Class B digital device, pursuant to Part 15 of the FCC Rules. These limits are designed to provide reasonable protection against harmful interference in a residential installation. This equipment generates, uses and can radiate radio frequency energy and, if not installed and used in accordance with the instructions, may cause harmful interference to radio communications. However, there is no guarantee that interference will not occur in a particular installation. If this equipment does cause harmful interference to radio or television reception, which can be determined by turning the equipment off and on, the user is encouraged to try to correct the interference by one or more of the following measures:

- Reorient or relocate the receiving antenna.
 - Increase the separation between the equipment and receiver.
 - Connect the equipment into an outlet on a circuit different from that to which the receiver is connected.
 - Consult the dealer or an experienced radio/TV technician for help.
- Caution: Changes or modifications not expressly approved by the party responsible for compliance could void the user's authority to operate the equipment.



Forbidden

Harmful gases or chemicals may cause corrosion and/or other danger to the Unit. Also, by coming into contact with hazardous substances, harm may occur to the people handling the Unit. Therefore, do not use or store it in any environment that is exposed to chemicals and harmful gases.



Strictly Follow

To prevent damage to the Unit from static electricity, remove static electricity from your body by touching metal around you (door knob, window frame) before touching the Unit. It may cause data loss or damage to the Unit and data.



Forbidden

Do not use or store the Unit in any of the following places. Doing so may cause electrocution, fire, and other adverse effects to the Unit and/or your computer.

- Areas exposed to direct sunlight
This will cause the inside of the Unit to become overheated and may cause fire, deformation, and/or other damage including malfunction.
 - Areas exposed to strong magnetic fields
This may cause damage including malfunction.
 - Areas exposed to water leakage
This may cause electrocution or other damage including malfunction.
 - Areas exposed to static electricity
This may cause damage including malfunction.
 - Areas exposed to excessive vibration
This may cause injury, malfunction, damage or loss of proper electrical contact.
 - Areas that are not flat or level
This may cause the Unit to fall and result in injury and/or damage.
 - Areas exposed to fire or overheating
This may cause damage including malfunction and deformation.
 - Areas exposed to excessive dust and dirt
This may cause damage including malfunction.
-

Table of Contents

Safety Precautions and Instructions	1
--	----------

Compliance Information	5
-------------------------------------	----------

Introduction

What is “Data Collector TR-57DCi”?	9
---	----------

Overview	9
----------------	---

Basic Functions	9
-----------------------	---

Installing the Software	11
--------------------------------------	-----------

Package Contents	12
-------------------------------	-----------

Appearance Diagram and Part Names	13
--	-----------

Explanation of Button Functions	13
---------------------------------------	----

Using the Operation Dial	14
--------------------------------	----

LCD Display and Operation	15
---------------------------------	----

Getting Ready

Installing the Batteries	18
---------------------------------------	-----------

About Battery Life	18
--------------------------	----

Turning the Power On and OFF	19
---	-----------

Turn ON the Power	19
-------------------------	----

Auto Power Off Function	19
-------------------------------	----

Making Clock Settings Manually	20
---	-----------

Communicating with the Computer	21
--	-----------

USB Communication	21
-------------------------	----

Serial Communication	22
----------------------------	----

Communicating with Data Loggers	23
--	-----------

Optical Communication	23
-----------------------------	----

Cable Communication	23
---------------------------	----

Infrared Communication (limited to the downloading of data)	23
---	----

Available Operations via Data Logger Communication	24
--	----

Basic Functions

Recording Start	26
------------------------------	-----------

Recording Settings for the Data Logger	26
--	----

Downloading Recorded Data	28
--	-----------

Downloading via Optical and Cable Communication	28
---	----

Downloading via Infrared Communication	29
--	----

Screen during Downloading	30
---------------------------------	----

If Downloading Recorded Data Fails	31
--	----

Graph Display	32
----------------------------	-----------

Reading a Graph	32
-----------------------	----

Event List Display	34
---------------------------------	-----------

Reading the Event List	34
------------------------------	----

Viewing Saved Data in Graph Form	36
---	-----------

Reading the Data List	37
-----------------------------	----

Reading Data Details	38
----------------------------	----

Other Functions

Operational Settings	40
-----------------------------------	-----------

Changing Unit of Temperature	40
------------------------------------	----

Adjusting the Backlight	40
-------------------------------	----

Adjusting Contrast	41
--------------------------	----

Checking Memory	41
-----------------------	----

Making Clock Settings	42
-----------------------------	----

Figuring Out Your Time Zone	42
-----------------------------------	----

Using the TR-57DCi in Areas that Observe Daylight Savings Time	42
--	----

Muting the Operation Beep	43
---------------------------------	----

Checking Battery Voltage	43
--------------------------------	----

Deleting Data	44
----------------------------	-----------

Deleting Selected Data	44
------------------------------	----

Deleting All Data	45
-------------------------	----

Others

Menu List	48
------------------------	-----------

Specifications	50
-----------------------------	-----------

Introduction

Explanation of Product Outline for TR-57DCi

- What is “Data Collector TR-57DCi”?
- Package Contents
- Appearance Diagram and Part Names

What is “Data Collector TR-57DCi”?

Overview

The TR-57DCi is a device designed to collect recorded data from data logger(s) already placed in the field. It is also possible to view collected data and start recording on data loggers in areas where a computer is not available.

Compatible Data Loggers

TR-71Ui / 72Ui / 74Ui / 76Ui / 77Ui, TR-71U / 72U / 73U, TR-71S / 72S, TR-71 / 72, TR-51i / 52i / 55i, TR-51S / 52S, TR-51A / 52 / 51, VR-71, RTR-51A / 52A / 53A*, RVR-52A*, RTR-51 / 52 / 52Pt / 53*, RVR-52*

*The TR-57DCi is not equipped with a wireless communication function.

Basic Functions

Easy Collection of a Variety of Data

The TR-57DCi can collect data from a wide variety of compatible data loggers.

Storage Capacity of 256,000 readings

One TR-57DCi has the capacity to store 16 units of TR-71U at full storage capacity (8,000 readings x 2ch).When downloading units at non-full storage capacity, it can store and manage up to 250 downloading sessions.

Collecting Recorded Data via Infrared Communication

The TR-57DCi can also use infrared communication to collect recorded data from any of the TR-7Ui and TR-5i Series Data Loggers. Using infrared communication releases the user from the burden of physically gathering the loggers to collect data.

Graph Display on High Quality LCD

Collected data can be viewed immediately on the spot without the need for a computer. The handy Operation Dial and buttons on the face of the Unit make it possible to move the cursor as well as zoom in and out, thereby making the checking of data a snap.

Handy Operation Dial for a Variety of Operations

Moving the Operation Dial up and down displays the various menu selections which can be easily selected by pressing in on the dial.

Make Recording Condition Settings

From the TR-57DCi, it is possible to make settings, such as for “Recording Start Date and Time”, “Recording Interval”, and “Recording Mode” for all compatible data loggers except the VR-71.

Installing the Software

Before Installing the Software, check the following.

- Is Windows operating properly?
- Quit all open applications.
- Make sure to install the software before connecting the Unit to a PC with a USB cable.

tandd.com/software/tdrec-trxx.html
tandd.com/software/td-graph.html

- * To install "T&D Recorder for Windows (TR-5,7xU)" it is necessary to have Administrator rights (Computer Administrator) for the computer in which you wish to install it.
- * Download "T&D Recorder for Windows (TR-5,7xU)" and "T&D Graph" from the T&D Website and install them to your PC.

After installation, "T&D Recorder for Windows (TR-5,7xU)" and "T&D Graph" will appear in the Windows Start Screen or Start Menu.

- If you have no internet access or prefer to install using a software DVD, "T&D Software SO-TD1" is also available as an option. Please contact your distributor for details. (tandd.com/purchasing/)

Battery Life Warning Display

When the battery power becomes low, a battery life warning mark will appear in the Unit's LCD display.

About 100 Days of Battery Life with One Hour Daily Use

The expected battery life for two AAA alkaline batteries (LR03) is as follows: used thirty minutes daily it should be about 160 days, used one hour daily it should be about 100 days, used two hours daily it should be about 50 days. In addition to AAA alkaline batteries, AAA Ni-Cd or AAA Ni-MH batteries (1.2V) may also be used.

* Battery life varies depending upon the type of battery, the measuring environment, the frequency of communication, and the ambient temperature in which it is used. Specifications and explanations used in this User's Manual are based on operations carried out with a new battery and are in no way a guarantee of your actual battery life.

Auto Power OFF Function

If the Unit is not used for about three minutes, it will automatically turn off to save battery power.

Backlight Function

The LCD Backlight allows the display to be easily read even in the dark. You can make changes in the Backlight ON/OFF by going to the [Main] Menu - [Set Functions] - [Set Backlight].

* If the Unit is not used for more than five seconds, the LCD Backlight will automatically turn off to save battery power. Once operation is re-started, it will automatically turn back ON.

Firmware Update Function

The firmware can be easily updated by connecting the target TR-57DCi with a USB communication cable to the computer. As newly compatible devices are released, firmware updates will be periodically released to support these changes. For more about how to update firmware and the latest update information, visit our T&D website (tandd.com).

Package Contents

The following items are included in the package:



Data Collector TR-57DCi

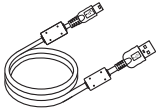

USB Mini-B Cable
US-15C

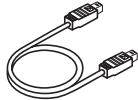

Serial Communication Cable
TR-6C10



AAA Alkaline Battery × 2



TR-57DCi User's Manual / Warranty
(this document)

*The mini-RS cable is used to connect T&D Data Collectors and Data Loggers.

Appearance Diagram and Part Names

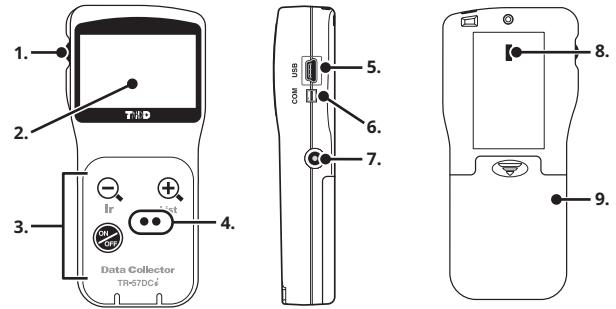

- 1. Operation Dial
- 2. LCD Display
- 3. Operation Buttons
- 4. Optical Communication Port
- 5. USB Connector (Mini-B)

- 6. Serial Connector
- 7. AC Adaptor Jack
- 8. Infrared Communication Port
- 9. Battery Cover

Explanation of Button Functions



- Press this to use infrared communication to start the downloading of recorded data from a data logger.
- Press while viewing a graph to zoom out.
- Press while entire graph is on display to move cursor to the lowest / highest value.



- Press to view the Data List Display.
- Press while viewing the Data List to view details for the data on display.
- Press while viewing a graph to zoom in on data.



- Press to turn the power ON / OFF.
(for details see p.21)

Using the Operation Dial

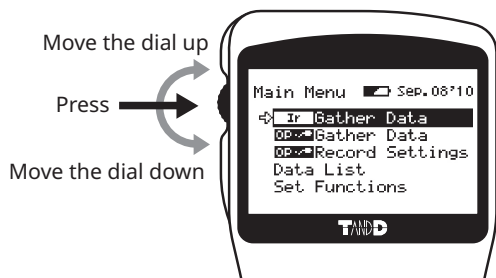

Moving the Dial Up and Down

- By moving the dial up and down, the arrow will move to allow you to choose the desired item.
- When setting a numerical value, by moving the dial up the value will become larger, and by moving the dial down the value will become smaller.

Pressing the Dial

- By pushing in on the dial, you can make a desired menu selection and complete or activate a setting.
- If you press and hold while downloading recorded data or viewing a graph display, you can change the channel on display.

LCD Display and Operation

Main Menu Window

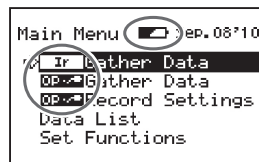

Menus for Infrared Communication



Menus for Optical or Cable Communication



When battery life goes low, a battery life warning mark will appear to inform you it is time to replace the battery. (See p.20)



An item marked with an arrow denotes it has been selected. By moving the Operation Dial up and down, the arrow will move accordingly. By pressing the dial, the selected item will be activated.

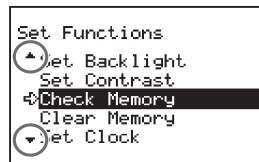

These indicate that there are more menu items above or below for view. By moving the Operation Dial up and down, you can scroll the display.

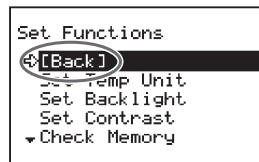

[Back]

After making necessary settings, move the arrow to [Back] and push the Operation Dial to return to the Menu Window.

Recorded Data Displays

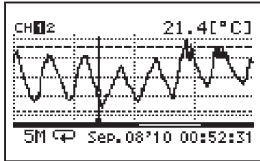

Graph Display

Temperature, Humidity, Barometric Pressure, Illuminance, UV Light, Voltage, and Pulse Data that have been downloaded to a TR-57DCi can be displayed in graph form.

See p.34 for details about the display.

Event List		5/168
▲	Jul. 01 '10 10:39:14	↑
	Jul. 01 '10 10:38:39	↓
	Jul. 01 '10 10:38:37	↑
	Jul. 01 '10 10:38:32	↓
▼	Jul. 01 '10 10:38:16	↓

Event List Display

Event Data that has been recorded by an RTR-52/52A and downloaded to a TR-57DCi can be displayed in the Event List.

See p.36 for details about the display.

Getting Ready

This section explains what needs to be done to get a TR-57DCi ready for use.

- Installing the Batteries
- Turning the Power On and OFF
- Making Clock Settings Manually
- Communicating with the Computer
- Communicating with Data Loggers

Installing the Batteries

Insert two AAA alkaline batteries as shown below. (AAA Ni-Cd or AAA Ni-MH batteries (1.2V) may also be used.)

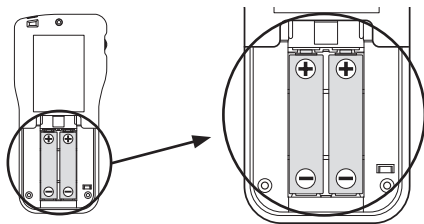

IMPORTANT:

- Always use two batteries of the same type.
- Make sure not to mistake + / -.
- The TR-57DCI cannot recharge batteries.

About Battery Life

When battery life goes low, a battery life warning mark will be displayed to inform you it is time to replace the battery. If battery life goes even lower, the Unit will automatically go into sleep mode in order to protect data. After going into sleep mode, the Unit will retain recorded data for about a month.

IMPORTANT:

- In sleep mode, the Unit cannot be turned on or operated as usual.
- When replacing the battery, if the battery has been removed for more than five minutes, the data stored in the Unit may be erased. It is recommended to first download any necessary recorded data to your computer before replacing the battery.
- Also, you will lose all data if the battery drains completely; make sure to replace the battery as soon as possible.

Battery Life Warning Mark



Turning the Power On and OFF

Turn ON the Power

Press the <ON/OFF> button or the Operation Dial to turn on the power.

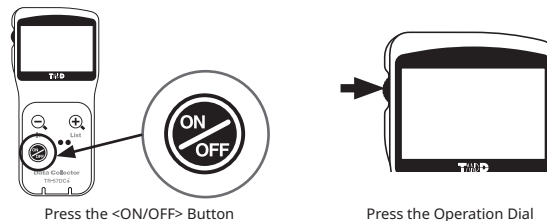

If the clock settings have not yet been made when the power is turned on, the following message will appear. By pressing the Operation Dial while the message is displayed, the clock settings window will automatically open. (See p.22)

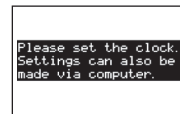

Turn OFF the Power

Press the <ON/OFF> to turn off the power. Turning off the power cannot be carried out from the Operation Dial.

IMPORTANT:

During communication, the power cannot be turned off even by pressing the <ON/OFF> button.

Auto Power Off Function

If the Unit is not in use for three minutes, the power will be automatically switched off in order to save battery power.

Making Clock Settings Manually

Please note that if the clock settings have already been made from your computer by using the software T&D Recorder for Windows (TR-5,7xU), this operation will not be necessary.

1. In the Main Menu, go to [Set Functions] and select [Set Clock].
2. Make clock settings.

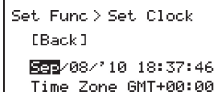

```
Set Func > Set Clock
[Back]
Sep/08/' 10 18:37:46
Time Zone GMT+00:00
```

(1) Move the Operation Dial up and down to change the selection item of the display in the order of month, day, year, hour, minute, second, and time zone.

(2) By pressing the dial, the value for that item will flash.

- (3) Change the value by moving the dial up and down.
 - (4) Press the dial again to set the selected value and move to the next settings item.
3. After having completed the clock settings, move the arrow to [Back] and press the dial to return to the Menu Window.

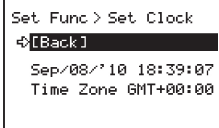

```
Set Func > Set Clock
[Back]
Sep/08/' 10 18:39:07
Time Zone GMT+00:00
```

[Time Zone]

By setting the region in which the TR-57DCi will be used the time difference will be automatically set. Daylight Savings Time settings must be set manually. (See p.44)

IMPORTANT:

- Please make sure that the date and time settings in the TR-57DCi are correct, if they are not, the recording start time and recording time of downloaded data will be incorrect.

Communicating with the Computer

To use a PC to download recorded data or make setting changes for the data logger it is necessary to use a USB communication cable US-15C (provided) or a serial communication cable (optional) to connect the TR-57DCi to your computer.

USB Communication

For TR-57DCi <-> PC Communication

IMPORTANT:

- Make sure the software "T&D Recorder for Windows (TR-5,7xU)" has been installed before connecting a TR-57DCi Unit to your PC.
- The USB device driver must be installed before trying to carry out USB communication. After installing the USB device driver, your computer will be able to detect and recognize any TR-57DCi Unit that is connected with a USB communication cable. Refer to the "Installing the USB Driver" section in the "T&D Recorder for Windows (TR-5,7xU) User's Manual" for the installation instructions.
- When connecting a TR-57DCi to a PC, connect only one unit at a time. If you connect multiple TR-57DCi Units at the same time, they may not be recognized properly.
- Make sure that the communication cable is completely inserted into the correct jack.

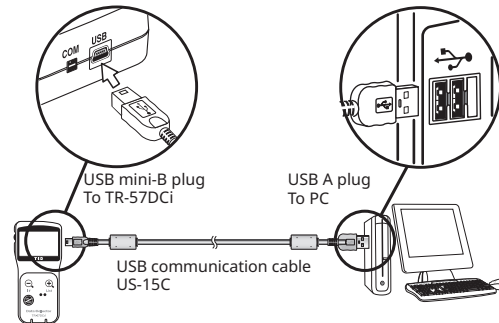

USB Port Mark



The USB communication cable is a USB-A plug <-> USB mini-B plug. Connect the USB-A plug end of the cable into a jack with a mark as shown at left.

Serial Communication

For TR-57DCi <-> PC Communication

Use an optional serial communication cable (TR-07C) to connect the TR-57DCi to a serial port on your PC.

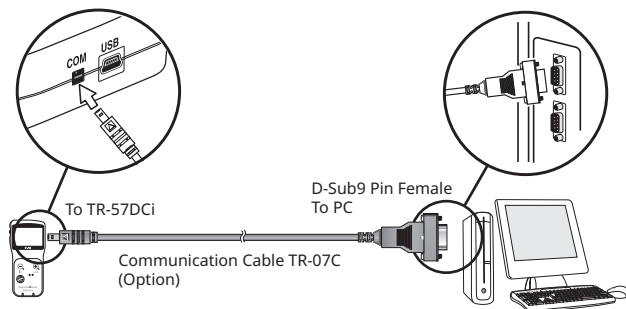

Serial Port Symbols



The communication cable connector is a D-Sub 9 pin female. Connect it to jack with a mark shown at left.

Communicating with Data Loggers

There are three ways to communicate between a TR-57DCi and a Data Logger: Optical Communication, Cable Communication, and Infrared Communication. The communication method you select will depend upon the type of Data Logger and the installation environment.

Optical Communication

Place the target logger face down on TR-57DCi.
TR-51i / 52i / 55i, TR-51S / 52S, TR-51A / 51 / 52
RTR-51 / 51A / 52 / 52A / 52Pt / 53 / 53A, RVR-52 / 52A

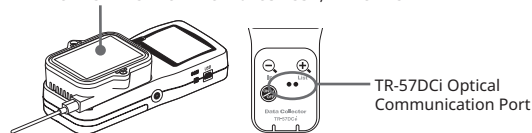

Cable Communication

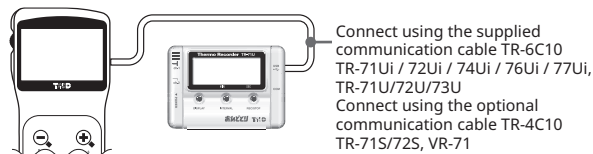

Infrared Communication (limited to the downloading of data)

Place the infrared port of the TR-57DCi and the target Data Logger face-to-face.

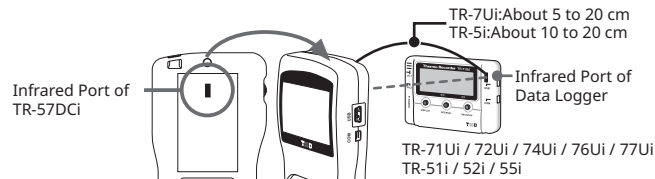

Available Operations via Data Logger Communication

[Set Recording Conditions]

Recording settings can be made such as "Recording Mode", "Recording Interval", and "Recording Start Date and Time (Programmed Start)".

[Read Settings]

The TR-57DCi can read and display all settings for the connected Data Logger.

[Download Recorded Data]

The TR-57DCi can collect recorded data from the Data Logger.

*Infrared Communication can be used only to download recorded data.

Basic Functions

This section explains the basic operations and functions of the TR-57DCi.

- Recording Start
- Downloading Recorded Data
- Graph Display
- Event List Display
- Viewing Saved Data in Graph Form

Recording Start

Recording Settings for the Data Logger

The following settings and changes can be made from the TR-57DCi Unit via Optical and Cable Communication.

- Recording Start
- Interval (Recording Interval)
- Recording Mode

IMPORTANT:

Once the recording settings have been transmitted to the data logger, all previously recorded data in the logger will be erased. It is recommended that you download and save necessary recorded data before making or changing recording settings.

1. Connect the Data Logger to a TR-57DCi Unit. (See p.25)
2. In the Main Menu, open [OP]Record Settings].
3. Make the necessary recording condition settings.

* For details about the setting items, see the next page.

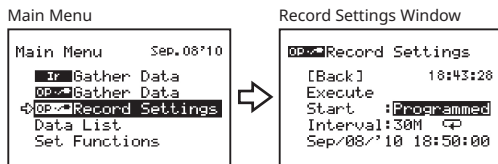

4. After having made the desired settings, adjust the arrow to [Execute] and press the Operation Dial to transmit the recording settings to the Data Logger.
5. Once the transmission has been completed, a message will appear on the display to inform you that communication was completed successfully. By pressing the Operation Dial you can go back to the Main Menu.

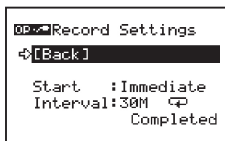

[Immediate Start / Programmed Start]

After having completed the recording settings, make settings for recording start date and time. First, make sure that the clock settings in the TR-57DCi are correct (See p.22). Also, make sure to download all necessary recorded data before executing any new recording start settings.

Immediate Start: Recording conditions will be transmitted to the Data Logger and recording will start immediately.

Programmed Start: Set the specific date and time for the Data Logger to start recording.

Programming the Date and Time to Start Recording



(1) Moving the Operation Dial up and down will change the selection item of the display in the order of month, day, year, hour, and minute. By pressing the dial, the value for that item will flash.

(2) Change the value by moving the dial up and down. Press the dial again to set the selected value and move to the next setting item.

[Interval (Recording Interval)]

Select from one of the following 15 choices. Move the Operation Dial up and down to choose the value, and press the dial to confirm it.

- 1, 2, 5, 10, 15, 20, or 30 seconds, 1, 2, 5, 10, 15, 20, 30 or 60 minutes

* Recording interval settings cannot be made for event recording.

[Recording Mode]

Move the Operation Dial up and down to choose the recording mode, and press the dial to confirm it.

One-Time →: Recording will stop when the storage capacity becomes full.

Endless ↻: Overwrite the oldest data when capacity is full.

Downloading Recorded Data

Use this to download recorded data from Data Loggers to the TR-57DCi.

Downloading via Optical and Cable Communication

1. Connect the Data Logger to the TR-57DCi. (See p.25)
2. In the Main Menu, open [Ir Gather Data] to start downloading.



When using data loggers for which the period of data to be downloaded is user-selectable, the settings window will appear as follows.



After the selection is made, adjust the arrow to [Execute] and press the Operation Dial to start downloading recorded data.

* If you wish to stop downloading, press the dial again.

3. A graph will appear showing the downloaded data.

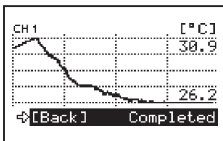

Downloading via Infrared Communication

1. In the Main Menu, open [Ir Gather Data] or press the <Q> Ir>button on the TR-57DCi Unit.



2. Under [Sel.Logger], select the Data Logger Series from which you wish to download data.

For the TR-7Ui Series, just select "TR-7". For the TR-5i Series, after selecting "TR-5i", then select the period of data to be downloaded.

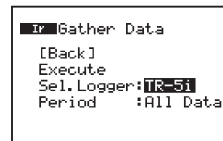

* When using the <Q> Ir>button to download data, this window will not appear and communication will be carried out according to the same settings as the previous session.

3. After adjusting the arrow to [Execute] and pressing the Operation Dial, place the infrared port of TR-57DCi and data logger face-to-face. (See p.25)

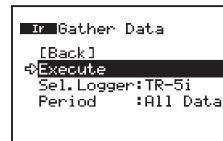

4. Once a response from the target data logger is confirmed, the downloading will start automatically.

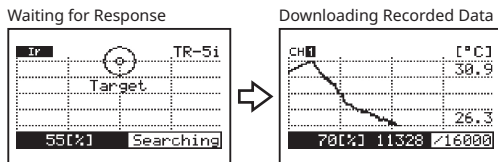

* If you wish to stop downloading, press the dial again.

5. The downloaded recorded data can be viewed in graph form.

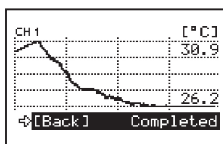

Screen during Downloading

As data is being downloaded, a changing graph and the high and low values for the received data will be continually shown. If you press and hold down the Operation Dial while downloading recorded data you can change the channel on display.

Press in Operation Dial while Downloading

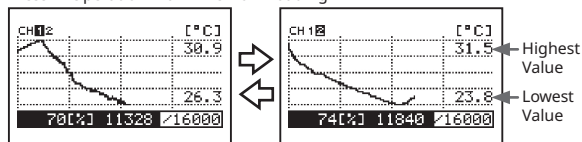

If Downloading Recorded Data Fails

Check the following:

Is there enough memory left in the TR-57DCi for the data?

If there is not enough memory remaining, the message [Memory Full] will appear and downloading will stop. Please save recorded data from the TR-57DCi to your PC and delete unnecessary data from the TR-57DCi to make space for downloading new data from the Data Logger.

- See p.43 for details about how to check for remaining memory capacity.
- See p.46 for details about deleting data.

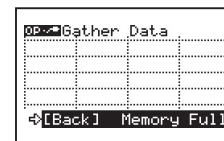

Has Infrared Communication been set to "Forbid"?

If a target TR-7Ui or TR-5i Series Logger has not been set to "Permit" Infrared Communication, it will be impossible to download recorded data via Infrared Communication. Using the software "T&D Recorder for Windows (TR-5,7xU)" or "Illuminance UV Recorder for Windows", make the necessary settings to permit Infrared Communication, and try downloading again.

- The application for the TR-76Ui does not have a setting to enable or disable infrared communication; Infrared communication is always enabled.
- For details about Infrared Communication Settings, see the Data Logger User's Manual or the [Help] Menu in the software.

Graph Display

In this display you can view in graph form the recorded data collected by the TR-57DCi.

A graph is displayed for each channel of data and can be scrolled left and right with the Operation Dial or by the buttons on the TR-57DCi.

Reading a Graph

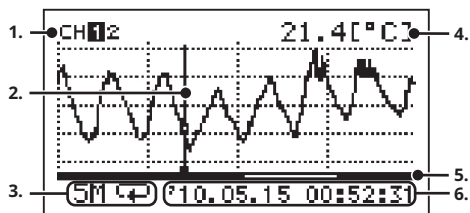

1. Displayed Channel

If there are multiple channels of recorded data, you can change the channel on display by holding in the Operation Dial (for about one second).

2. Cursor

By moving the Operation Dial, you can scroll the cursor left and right to view the recording date and time and measurement for that point where the cursor is positioned.

3. Recording Interval and Mode

The "Recording Interval" and "Recording Mode" for the displayed data are shown here.

S: Seconds, M: Minutes, H: One Time, ∞: Endless

4. Measurement at Cursor Position

The corresponding measurement value is displayed for the date and time where the cursor is positioned.

[°C/°F]: Temperature, [%RH]: Humidity, [hPa]: Barometric Pressure, [lx]: Illuminance, [mW/cm²]: UV Light, [V]: Voltage, [mA]: 4-20mA, [Pulse↑] [Pulse↓]: Pulse, [ppm]: CO2 Concentration

↑: Pulse Rising (OFF -> ON), ↓: Pulse Falling (ON -> OFF)

5. Graph Display Range

From the entire range of recorded data this line shows the range of data currently on display. You can use the <List> button on the TR-57DCi to zoom in and the <Ir> button to zoom out on data.

6. Date and Time of Cursor Position

The date and time of the current cursor position are shown here.

Event List Display

When using TR-57DCi to collect event data from RVR-52/52A, all data can be viewed in the event list.

Reading the Event List

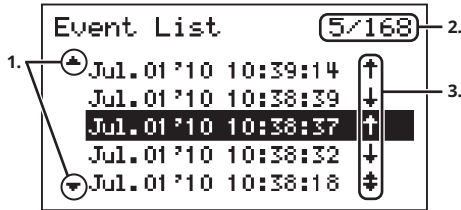

1. ▲, ▼

These show that data exists outside of the current display area. By using the Operation Dial or the <Q>Ir / <@>List buttons on the TR-57DCi, it is possible to scroll up and down to bring data into view.

2. Number of Readings

This shows what number record out of the total number of records is being currently highlighted by the cursor. (The above diagram shows that the data being highlighted is 5th record out of a total of 168.)

3. Arrows

- ▲: Rising Edge Data
- ▼: Falling Edge Data
- ⚡: Both Rising and Falling within 1 second

Events within an input voltage range of 0 to 30V are measured for every 1 second and the time and date are recorded if any change, rising (Lo->Hi) or falling (Hi->Lo), occurs and lasts for more than 1 second.

Example of Changes between Rising and Falling

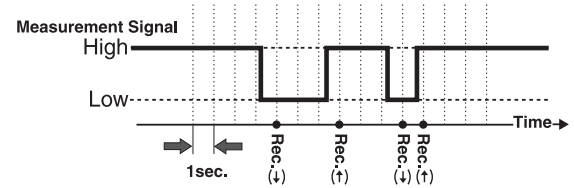

When Both Rising and Falling occur Within 1 Second

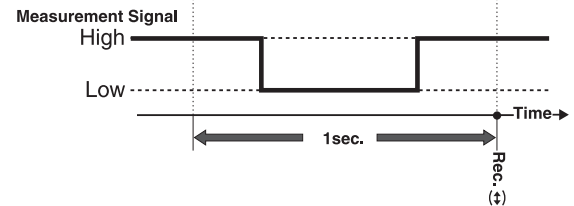

Viewing Saved Data in Graph Form

1. Select [Data List] in the Main Menu, or press the <@,List> button on the TR-57DCi.
2. From the Select Data display, choose the data you wish to view in a graph by moving the Operation Dial up and down, and press dial to confirm.

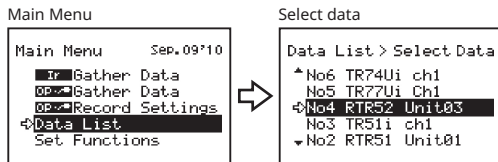

The selected data will be highlighted. See the next page for the details about the Data List.

3. Click on [Display Graph] to view the Graph for the selected data. To view event data, after opening [Data List] click on [Event List].

For Temperature, Humidity, Barometric Pressure, Illuminance, UV, Voltage, Pulse, and CO2 Data

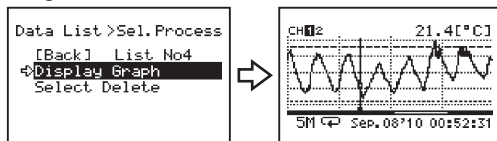

For Event Data

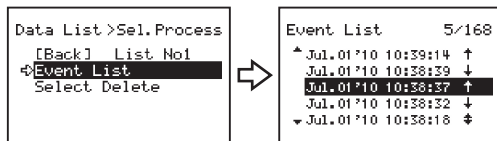

Reading the Data List

The notation may differ slightly depending on the Data Logger being used.

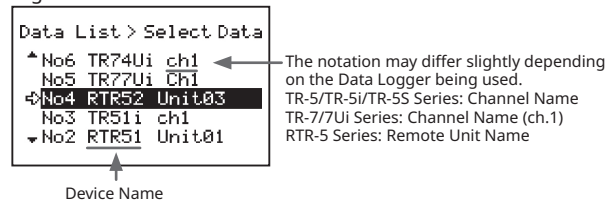

Device Name:

The device name of the Data Logger is shown here. TR-71Ui / 71U / 71S will be shown as "TR-71x", and TR-72Ui / 72U / 72S will be shown as "TR-72x".

Channel Name:

The Channel Name entered when Recording Condition Settings were made via PC.

Remote Unit Name:

The Remote Unit Name entered for a RTR-5 Series Data Logger when Recording Condition Settings were made via PC.

Reading Data Details

By clicking on the <@List> button in the Data List Display, the details of that data can be viewed.

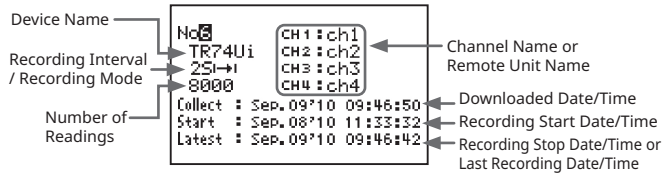

About Recording Interval / Recording Mode

The Recording Interval and Mode will be shown as below.

- 2S → Recording Interval: 2 seconds, Recording Mode: One-time
- 30M → Recording Interval: 30 minutes, Recording Mode: Endless

Other Functions

This section contains explanations about other operational settings for the TR-57DCi, as well as, how to delete recorded data.

- Operational Settings
- Deleting Data

Operational Settings

Changing Unit of Temperature

By changing the Unit of Temperature, the Recorded Data display in the TR-57DCi and the LCD display on the target Remote Unit(s) for which recording was started from the TR-57DCi will be also be changed to reflect the new setting.

1. In the Main Menu, open [Set Functions] and [Set Temp Unit].

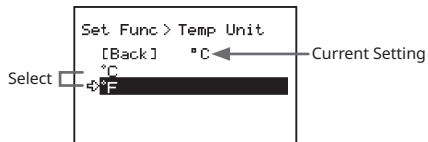

2. Move the arrow to [°C] or [°F] and press the Operation Dial.
3. Move the arrow to and click on [Back] to return to the Main Menu.

Adjusting the Backlight

1. In the Main Menu, open [Set Functions] and [Set Backlight].

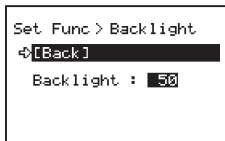

2. Move the Operation Dial up to make the light brighter and down to make it darker.
3. Press the Operation Dial to return to the Main Menu.

Adjusting Contrast

1. In the Main Menu, open [Set Functions] and [Set Contrast].

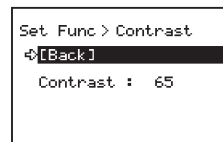

2. Move the Operation Dial up to make the display darker and down to make it lighter.
3. Press the Operation Dial to return to the Main Menu.

Checking Memory

1. In the Main Menu, open [Set Functions] and [Check Memory].

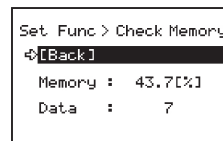

2. Press the Operation Dial to return to the Main Menu.

Making Clock Settings

1. In the Main Menu, open [Set Functions] and [Set Clock].

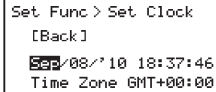

```
Set Func > Set Clock
[Back]
Sep/08/10 18:37:46
Time Zone GMT+00:00
```

- (1) Move the Operation Dial up and down to change the selection item of the display in the order of month, day, year, hour, minute, second, and time zone.
- (2) By pressing the dial, the value for that item will flash.

- (3) Change the value by moving the dial up and down.
- (4) Press the dial again to set the selected value and move to the next settings item.

2. After having completed the clock settings, move the arrow to [Back] and press the dial to return to the Menu Window.

Figuring Out Your Time Zone

Right click on the clock in the task bar of your computer, and select [Adjust Date/Time].

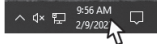

Set the displayed time zone into the TR-57DCi.

- Please note that depending on your Windows OS, the time zone may be displayed in UTC format instead of GMT.

Using the TR-57DCi in Areas that Observe Daylight Savings Time

When daylight savings time begins, move the clock settings in the Unit one hour ahead and add one hour to the time zone.

EX1: When the clock is 12:00 and the time zone is GMT+07:00:

Change the clock to 13:00 and the time zone to GMT+08:00.

EX2: When the clock is 9:00 and the time zone is GMT- 08:00:

Change the clock to 10:00 and the time zone to GMT - 07:00.

When daylight savings time ends, set them back to the original values.

Muting the Operation Beep

1. In the Main Menu, open [Set Functions] and [Beep].

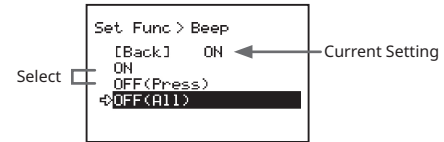

2. Move the arrow to either [ON] or [OFF] and press the Operation Dial to confirm.
OFF (Press): Turns off sound for button operation. Warning buzzer will still beep.
OFF (All): Turns off all beeps including the warning buzzer.
3. Move the arrow to [Back] and press the dial to return to the Main Menu.

Checking Battery Voltage

1. In the Main Menu, open [Set Functions] and [Battery Voltage].

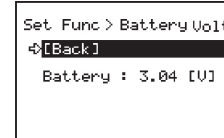

2. Press the Operation Dial to return to the Main Menu.

Battery Voltage:

When battery power depletes to about 2.30V, the battery life warning mark will appear.

Deleting Data

Deleting Selected Data

1. In the Main Menu, open [Data List]. Select the data you wish to delete and press the Operation Dial.

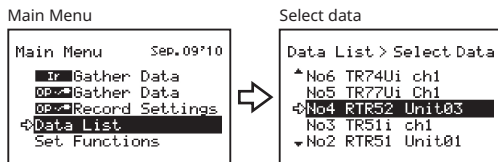

2. Move the arrow to [Select Delete] and press the Operation Dial.

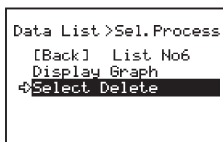

3. A confirmation screen will appear. Select [Execute] to delete the selected data or [Back] not to delete it, and press the Operation Dial.

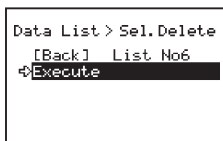

4. Upon completion of deletion, it automatically returns to the data selection display.

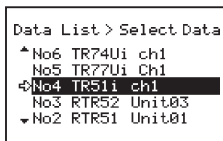

Deleting All Data

1. In the Main Menu, open [Set Functions] and [Clear Memory].

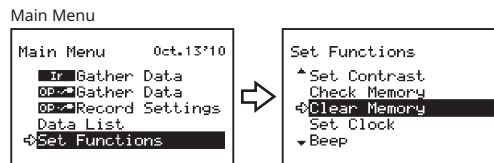

2. A confirmation screen will appear. Select [Execute] to delete the selected data or [Back] not to delete it, and press the Operation Dial.

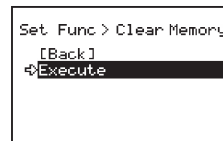

3. Upon completion of deletion, press the Operation Dial to return to the Set Functions Menu.

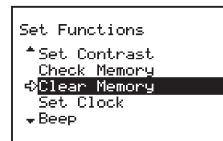

Others

- Menu List
- Specifications

Menu List

Gather Data

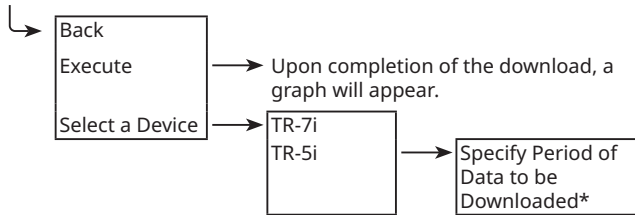

*The period for download can only be specified for TR-5i Series Loggers.

Gather Data

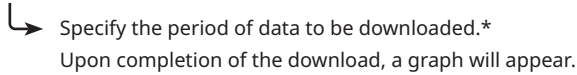

*When using data loggers for which the period of data to be downloaded is user-selectable, the settings window will appear as follows.

Recording Settings

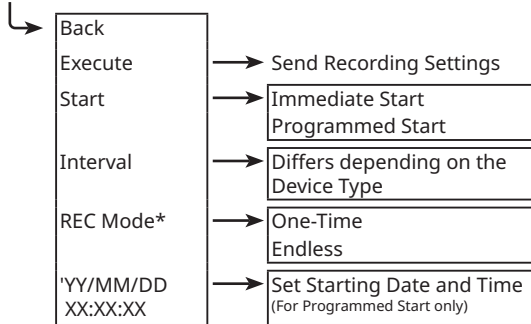

* For TR-71/72, only One-Time mode can be selected.

Data List

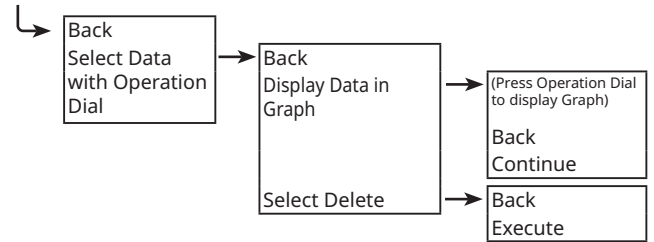

Set Functions

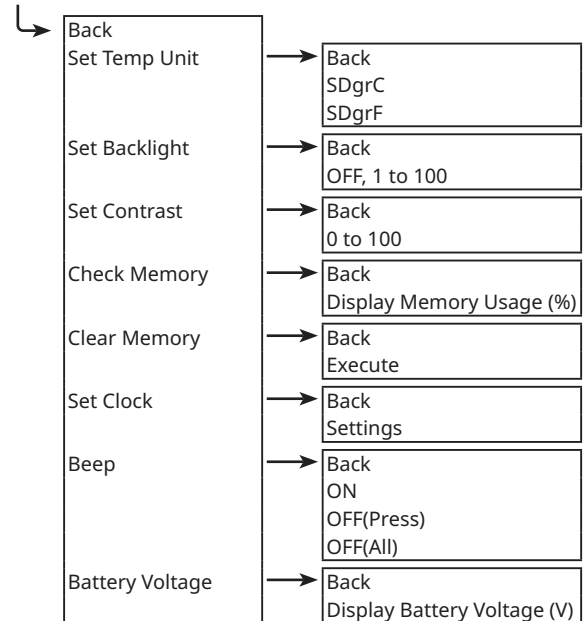

Specifications

Compatible Devices	TR-7Ui Series: 74Ui / 76Ui / 73U (including S Type) TR-5i Series: TR-511 / 52i / 55i-TC / 55i-Pt / 55i-V / 55i-mA / 55i-P Discontinued: VR-71, TR-71Ui/72Ui/77Ui, TR-71S/72S, TR-71U/72U, TR-51S/52S, TR-51A/52, RTR-51/51A/52/52A/52Pt/53/53A, RVR-52A (including H Type and L Type)
Storage Capacity	Up to 256,000 readings When downloading from units filled to logging capacity: - 16 units of TR-71Ui/72Ui/77Ui - 10 units of TR-73U/76Ui - 7 units of TR-74Ui - 16 units of TR-51i/52i - 15 units of TR-55i When downloading from units of any type containing small amounts of data, it can store and manage up to 250 download sessions.
Communication Interfaces	Optical Communication Infrared Communication (*1): IrPHY 1.2 low power Serial Communication (*2) USB 2.0 (Mini-B connector)
Communication Time	TR-7Ui Series - Via infrared communication (TR-76Ui) : About 63 sec. - Via infrared communication (TR-74Ui) : About 77 sec. TR-5i Series - Via optical communication: About 24 sec. - Via infrared communication: About 55 sec.
Power	AAA Alkaline Battery LR03 x 2, AAA Ni-MH Battery x 2, USB bus power, AC adaptor AD-06A1 or AD-06C1
Battery Life	About 100 days at 1 hour of daily use (*3)
Dimensions	H 125 mm x W 58 mm x D 25.8 mm (excluding protrusions)
Weight	Approx. 90 g
Operating Environment	Temperature: 0 to 50 °C Humidity: 90 %RH or less (no condensation)
Software (*4)	PC Software (Windows) T&D Recorder for Windows (TR-5, 7xU), T&D Graph

- *1. Infrared Communication can be used only to download recorded data, and not to make recording settings.
- *2. The optional serial communication cable TR-07C is necessary for serial communication with PC.
- *3. Battery life in the table above is for two AAA Alkaline type batteries, and varies depending upon multiple factors including ambient temperature, frequency of communication, and battery performance. All estimates are based on operations carried out with a new battery and are in no way a guarantee of actual battery life.
- *4. Software on CD-ROM is not supplied with the product. Free software download and information on OS compatibility is available on the Software page of our website at tandd.com/software/.
The specifications listed above are subject to change without notice.

T&D Corporation

For product information or questions contact us at:

tandd.com/support/

We have opened an English Website for your convenience. Here you can find information about our company, news, products, upcoming events, software and user's manual downloads, as well as, other support. Please stop by and see what we have to offer.

Refer to the Manual & Help for operational details

tandd.com/manual/

This is printed on recycled paper.