



Thermo Recorder TR-81

User's Manual

Thank you for purchasing our product. Carefully read this instruction manual before using this unit.

Notices about this User's Manual

- Please read this manual carefully before using the product.
- This manual can not be reprinted, so please keep it in a safe place.
- We cannot guarantee nor are we responsible for safety if this product is used in any manner other than was intended.
- Please follow the safety precautions carefully.
- Contents of this manual may be altered according to improvements made to the product without notification.
- On screen messages in this manual may vary slightly from the actual messages.
- Figures in this manual may be slightly simplified and may differ from the actual product.
- Please notify us of any unclarity, mistakes or errors in this manual.
- Reproduction or use of any part or all of this manual is strictly forbidden.
- Please carefully read the guarantee and provisions for free repair.
- Microsoft and Windows are registered trademarks of Microsoft Corporation in the United States and/or other countries.
- Windows Vista is either a registered trademark or trademark of Microsoft Corporation in the United States and/or other countries.
- Company names and product names are trademarks or registered trademarks of each company.

FCC Compliance Statement for American Users

This device complies with Part 15 of the FCC Rules.

Operation is subject to following two conditions: (1) this device may not cause harmful interference, and (2) this device must accept any interference received, including interference that may cause undesired operation.

NOTE:

This equipment has been tested and found to comply with the limits for a Class A Digital Device, pursuant to Part 15 of the FCC Rules. These limits are designed to provide reasonable protection against harmful interference in a residential installation. This equipment generates, uses and can radiate radio frequency energy and, if not installed and used in accordance with the instructions, may cause harmful interference to radio communications.

However, there is no guarantee that interference will not occur in a particular installation. If this equipment does cause harmful interference to radio or television reception, which can be determined by turning the equipment off and on, the user is encouraged to try to correct the interference by one or more of the following measures:

- Reorient or relocate the receiving antenna.
- Increase the separation between the equipment and receiver.
- Connect the equipment into an outlet on a circuit different from that to which the receiver is connected.
- Consult the dealer or an experienced radio/TV technician for help.

Warning

This equipment has been verified to comply with the limits for a Class A personal digital device, pursuant to Subpart B of Part 15 of FCC Rules. Only peripherals (computer input/output devices, terminals, printers, etc.) certified or verified to comply with the Class A or B limits may be attached to this equipment. Operation with non-certified or non-verified personal computer and/or peripherals is likely to result in interference to radio and TV reception. The connection of a non-shielded equipment interface cable to this equipment will invalidate the FCC Certification of this device and may cause interference levels which exceed the limits established by the FCC for this equipment.

You are cautioned that changes or modifications not expressly approved by party responsible for compliance could void your authority to operate the equipment.

Table of Contents

Introduction

Safety Precautions and Instructions	2
Software User Agreement	4
What is Thermo Recorder TR-81 ?	5
Contents of Package	6
How to use the Attachment Plate	6
Part Names and Functions	7
Explanation of the LCD Display	8

Getting Ready

Preparing the Thermo Recorder	10
Install the Battery	10
Turn Power On	11
Replacing the Battery	12
Installing the Software	13
Communicating with your Computer	14
Connecting the TR-81 to Your Computer	14
Setting up the Communication Port	14

Basic Usage

Starting to Record	16
Start Recording via Computer	16
Start Recording via Base Unit	17
Downloading Recorded Data	18

Temperature Humidity Graph

Temperature Humidity Graph	20
Screen Names and Functions	20
Saving Recorded Data	22
Creating Text File	23

Other

Troubleshooting	24
Specifications	27

Safety Precautions and Instructions

Please follow these instructions carefully.

Warnings

- This product has been designed for private or industrial use only. It is not for use in situations where strict safety precautions are necessary such as in connection with medical equipment whether directly or indirectly.
- We are not responsible for any malfunction or trouble caused by the use of our product or by any problem caused by the malfunction of our unit. Please understand this before using our product.
- Leakage of water or other foreign objects into the unit may cause fire or malfunctioning. If something does leak into the unit make sure to remove the batteries immediately.
- Maintenance or modification of the main unit by anyone other than our authorized mechanics is strictly prohibited. This could lead to malfunctioning.
- Avoid smoke, steam, high humidity and dust. These could lead to malfunctioning.
- It is extremely dangerous to swallow batteries. Install and keep all batteries, sensors and the Thermo Recorder Unit a safe distance from and out of the reach of small children.
- The Thermo Recorder is a device designed to measure and record temperature. Do not use this unit for any purpose other than temperature measurement.
- The sensor may have a sharp edge, please take care when handling it.

Handling Precautions

- Dropping the unit or exposing it to a strong impact may cause malfunctioning.
- If the batteries lose all power all recorded data and settings will be lost. Please make sure to change the batteries before they lose power.
- Battery life varies depending on recording conditions and battery quality. Life may be shorter than published.
- Battery terminals may provide insufficient contact due to age or vibration. This may lead to data loss so please be sufficiently careful.
- If the unit will not be used for a period of time, for safety reasons please remove the battery. They may leak and lead to malfunctioning.
- This unit is not waterproof. Do not use in an area where contact with water may occur.

Handling Precautions

- Dropping the unit or exposing it to a strong impact may cause malfunctioning.
- If the batteries lose all power all recorded data and settings will be lost. Please make sure to change the batteries before they lose power.
- Battery life varies depending on recording conditions and battery quality. Life may be shorter than published.
- Battery terminals may provide insufficient contact due to age or vibration. This may lead to data loss so please be sufficiently careful.
- If the unit will not be used for a period of time, for safety reasons please remove the battery. They may leak and lead to malfunctioning.
- This unit is not waterproof. Do not use in an area where contact with water may occur.

Placement Precautions

- Condensation may occur if the unit is moved from one environment to another where the difference in temperature is great. Use the unit in an environment where the ambient temperature is from -10 to 60 °C and the humidity is 90% RH or less.
- Do not leave the unit in direct sunlight or in excessively hot or humid places for long periods of time. It may cause fire or otherwise cause the unit to malfunction.
- Do not expose the unit to harmful gases or chemicals. It may cause corrosion and / or other danger to the unit and to people handling the unit.
- Exposing the unit to mechanical vibration may cause insufficient contact and data loss. Make sure to place the unit in a steady environment.
- Avoid placing the unit in an area exposed to strong magnetic fields.

Software User Agreement

Escape Clauses

- T&D Corporation does not guarantee the operation of Hi for Windows.
- T&D Corporation shall not accept any responsibility for any damage whether direct or indirect that results from the usage of Hi for Windows.
- Specifications of Hi for Windows may be subject to change and service may be terminated without advance notice to the user. In such a case, T&D Corporation shall not be responsible for any damages, whether direct or indirect, from the inability to use Hi for Windows.
- T&D Corporation has no obligation to correct any defects found in Hi for Windows.

Copyright

- All copyrights for Hi for Windows, including all of the programs and all related documents, are the sole property of T&D Corporation.
- The reprinting or redistribution for commercial purposes whether in part or in whole, in magazines or as a part of any product is strictly forbidden without the expressed consent of T&D Corporation. Any inquires concerning commercial redistribution should be directed to the Sales Department of T&D Corporation.
- Please do not attempt to make any changes or modifications to Hi for Windows.

What is Thermo Recorder TR-81 ?

This product is a thermo recorder that makes use of a platinum resistance sensor to measure and record temperature. Recorded data is then downloaded into a computer using our special software where it can be easily displayed in table or graph form.

Basic Functions

- **Designed to be used with a three wire Pt100 Temperature Sensor.**
- **Measurement Range is from -200 to 600 °C.**
- **The unit has two separate channels for measuring and recording temperature.**
- **Data capacity is 8,000 readings × 2 channels.**
- **One Lithium Battery allows recording for 5-8 months.**

Basic Functions of Hi for Windows®

By utilizing our special software you are able to download all recorded data into your computer where it can be easily made into graphs and tables for printing, saving or saving as text file data.

- **Can process and display up to 8 channels at the same time.**
- **Can create a wide array of graphs with ease.**
- **Can create a graph for a chosen period.**
- **Automatically calculates and displays the highest and lowest values as well as the average in graph or table form.**
- **The text file data can be manipulated by all popular spreadsheet software.**

Contents of Package

The following items are included in the package.

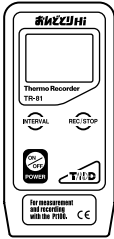

1 Thermo Recorder Unit
(TR-81)



1 Software disk
(Hi for Windows®)

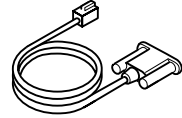

1 Communication Cable
(RS-232C: D-SUB 9 pin)



1 Lithium Battery

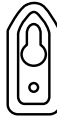

1 Attachment Plate
(1 screw)



1 User's Manual

How to use the Attachment Plate

Use the attachment plate to hang the Thermo Recorder on the wall, etc.

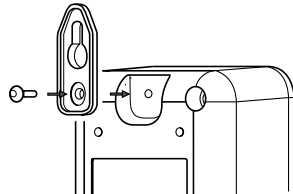

Part Names and Functions

[The Front]

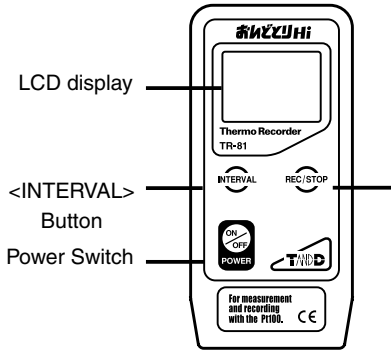

[The Rear]

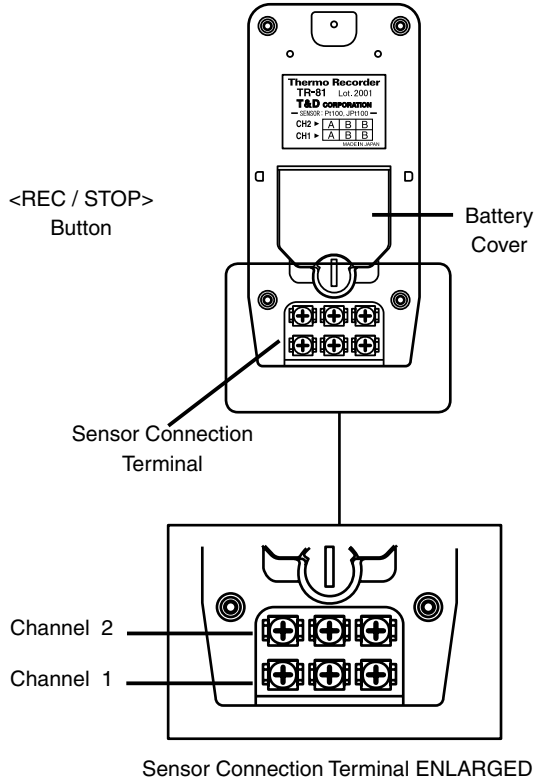

[The Side]

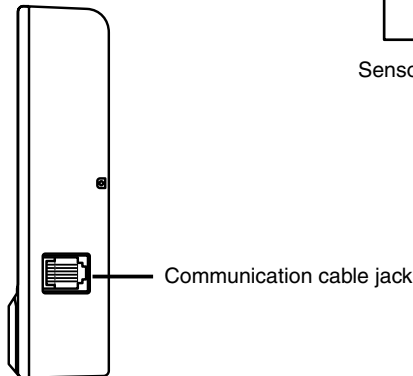

Explanation of the LCD Display

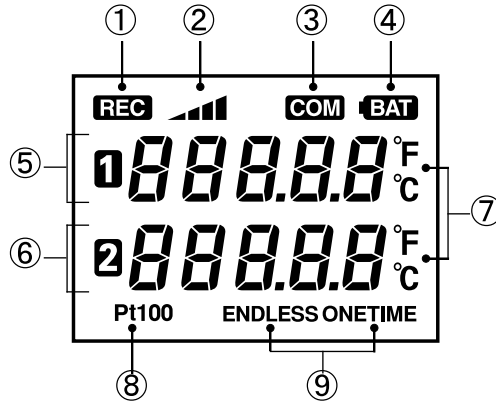

① **REC**...Recording Indicator.

② ...Amount of Recorded Data.

[DISPLAY]

Endless Mode... Indicates recording will continue.



One Time Mode...Changes to FULL and recording stops.

③ **COM**...Indicates communication in progress.

④ **BAT**...Battery Life Warning.

⑤ ...Displays Data Measurement for Channel 1.

⑥ ...Displays Data Measurement for Channel 2.

⑦ °C °F...Temperature Unit Display.

Display unit can be changed via. computer.

⑧ **Sensor Type (Pt100)**

⑨ **Recording Mode**

ENDLESS: When the recorded data goes over 8000 units the oldest data is overwritten and recording continues.

ONETIME: When the recorded data reaches 8000 units the REC indicator goes off and recording stops.

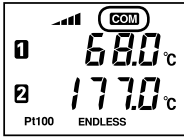

COMMUNICATING

The COM mark appears when communication is taking place between the unit and your computer, i.e. when setting up recording, or downloading data.

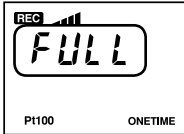

FULL

The FULL mark appears when 8000 units of data have been recorded in ONETIME Mode. This indicates that recording has stopped and it is important to download the data into your computer as soon as possible.

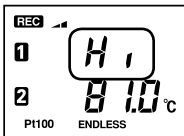

OVER THE MEASURABLE RANGE

The Hi mark indicates that the temperature is over the measurable range of 600°C.

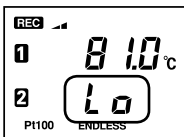

BELOW THE MEASURABLE RANGE

The Lo mark indicates that the temperature is below the measurable range of -200°C.

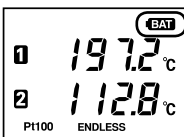

BATTERY LIFE WARNING

The BAT message appears whenever the battery power is low. Recording is still possible while lamp is on, but when blinking recording will be discontinued. Please change the battery as soon as you see the warning lamp come on.

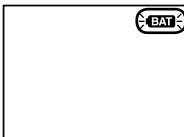

SLEEP MODE

The battery lamp will begin to blink when power is very low, recording will stop and the unit will automatically go into sleep mode. It is important to change the battery before it begins to blink.

Preparing the Thermo Recorder

Install the Battery

1. Using a coin, turn the battery cover lock as shown in figure 1 to open cover.

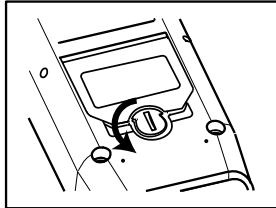

Figure 1: Backside of Main Unit

2. Install Lithium Battery (CR2) as shown in figure 2.

- Use only new batteries.
- Make sure the battery is in the right direction.

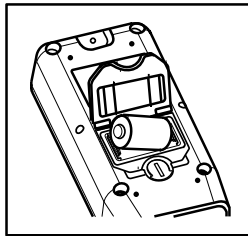
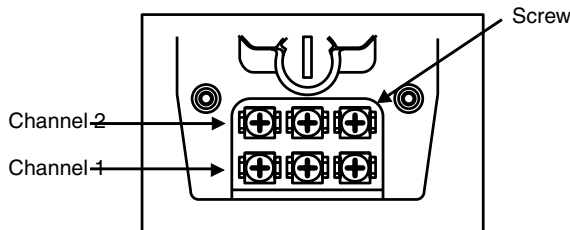

Figure 2: Backside of Main Unit

3. Turn the cover lock in the opposite direction of figure 1 to close cover.

Connect the Sensor

1. To connect the sensor, loosen the screws of the channel to be connected.



Backside of Unit Sensor Connection Terminal

2. Connect Sensor to Terminal, making sure to follow directions on the sticker on the backside of unit. (See figure below)

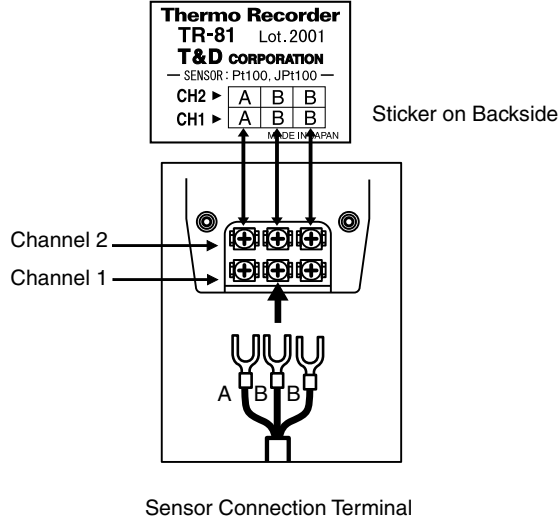

[Sensor Wiring Figure]

- Usually all three wired platinum resistance sensors are wired as in the figure below. Terminals are represented with the letters A / B or color red / white.

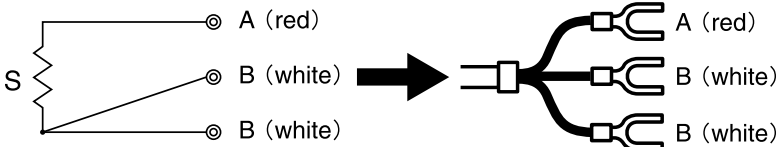

*In the case of a 4-wire sensor, one of the A wires will be left unused.

3. After connecting the sensor, tighten the screws to prevent slipping.

Turn Power On

- The back up power function ensures no data loss even if the power switch is turned OFF.



Replacing the Battery

Time to change the battery

- * Once the BAT lamp appears on the display make sure to change the battery as soon as possible. If you change the battery before the BAT lamp begins to blink, recording will continue uninterrupted and without any loss of data.
- * If the batteries go completely dead, all recorded data and recording settings will be lost, so please be attentive to the BAT lamp.

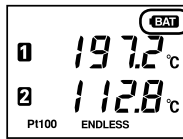

- * The following chart can give you a general idea as to battery life.

	Recording Int. of more than 2 ses'	Recording Int. of 1 second
Time before BAT lamp (warning) appears.	Maximum 8 months	Maximum 5 months

- The main unit can remain in working condition for about 2 minutes without a battery.
- Battery life depends on many conditions including the recording environment, the recording interval, the amount of communication, the surrounding temperature, and others. This explanation is based on using a new battery and in no way should be taken as a guarantee of battery life.

After changing the battery

- * If you changed the battery when the BAT lamp was on.

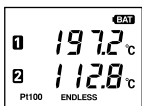

→ Change battery →

Returns to same condition as before lamp appeared. Recording continues without trouble.

- * If you changed the battery when the BAT lamp was blinking.

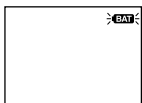

→ Change battery →

The power automatically goes off. Make sure to turn back on.

Note:

If the BAT lamp is blinking make sure to download all data as soon as possible. If you press the [REC/ STOP] button on the main unit a new recording session will begin and all previously recorded data will be automatically deleted.

Installing the Software

1. Start Windows and login using a User Account with Administrator (Computer Administration) rights.

2. Place the CD-ROM into your CD or DVD drive.

3. The [Install Program] window will appear.

If the [Auto Play] window appears:

Click on [Run setup.exe].

If the [Install Program] window does not appear automatically:

Click on the [setup.exe] icon in the CD/DVD drive.

4. Follow the directions as they appear to complete the installation.

If a window appears asking if you would like to install this device software, click [Install].

5. After installation, “Hi for Windows” will appear in the Windows Start Menu.

Communicating with your Computer

Connecting the TR-81 to Your Computer

Connect a TR-81 data logger to your computer so that communication can occur.

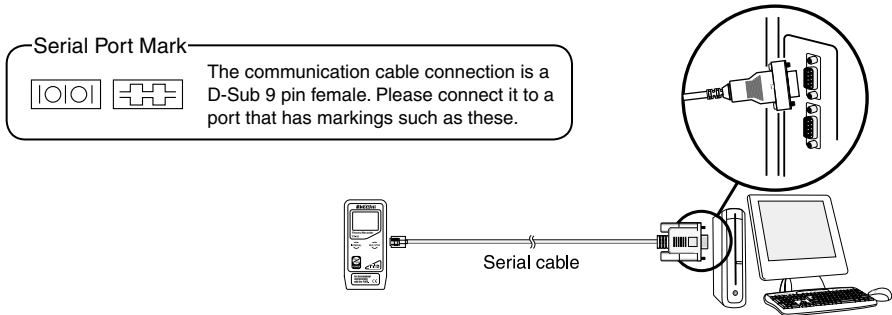

** If the cable is connected to the wrong port, communication cannot take place.*

** Be sure to securely connect the cable to avoid any communication failure due to a loose connection.*

Setting up the Communication Port

1. In the [Communication] Menu, select [Select Serial Port].
2. Check the COM port you wish to use from COM1 to COM9.

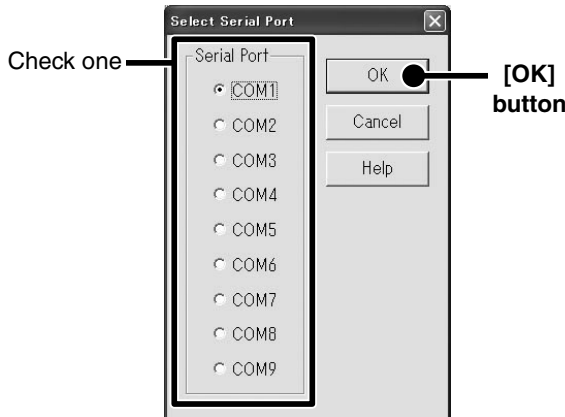

3. Click the [OK] button to finish the setting process.

** If no port is detected, see [Troubleshooting] on pages 24-26.*

Starting to Record

There are two ways to begin the recording process.

Start Recording via Computer

You can set the day and time you want recording to start and can set or change all recording functions via the software.

1. Start [Hi for Windows]
2. From the [Communication] Menu choose [Start Recording...]
3. The following screen will be displayed from which all settings can be made.

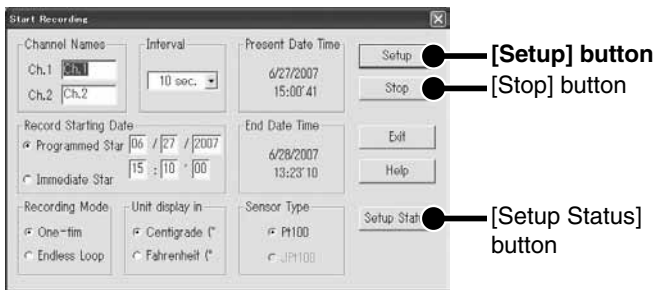

- Recording Interval...1/2/5/10/15/20/30 seconds, 1/2/5/10/15/20/30/60 minutes
 - Recording Mode...One Time / Endless Loop
 - Temperature Unit Display...°C (Celsius) / °F (Fahrenheit)
 - Sensor Type...Pt100
 - Record Starting Date...Programmed / Immediate
4. By clicking [Setup] the settings will become active. The LCD Display on the main unit will display a blinking REC until the set recording date and time arrives.

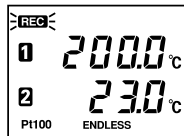

- When you want to stop the recording function simply click on the [Stop] button in the [Recording Start] display in the [Communication] pull down menu. You can cancel a programmed start in this same way.
- When you want to check the recording settings go to the [Recording Start] display in the [Communication] pull down menu and click on [Present Settings] and the present settings will be displayed. **YOU CAN NOT CHANGE THE SETTINGS WHILE RECORDING.**

Start Recording via Base Unit

By pushing the REC button you can begin recording immediately as well as set or change the recording interval

1. Set the Recording Interval by pressing the [INTERVAL] button. Each time you press, it will take you to the next possible interval. A pause of 3 seconds will set the interval and return you to the main display.

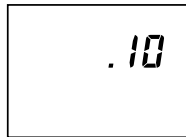

10 seconds



10 minutes

2. Start Recording by pressing down on the [REC/STOP] button for more than 2 seconds; the REC lamp will appear lit on the display.

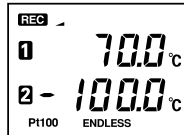

- With some computer models, even though you have set a programmed start and the unit is in waiting mode, by pressing [REC/STOP] recording will begin immediately.
- While recording, Recording will stop if you hold down the [REC/STOP] button for more than 2 seconds.
- If you want to make any changes to the settings other than recording interval please see [Start Recording Via Computer]

Note:

If you press on the [REC/STOP] button when the REC lamp is not lit, the next recording will begin and any former data will be automatically deleted.

- When you want to stop a recording session press the [REC/STOP] button for 2 or more seconds.
- When you want to check the recording interval while recording press the [INTERVAL] button and it will appear on the display. **YOU CAN NOT MAKE CHANGES WHILE RECORDING.**

Downloading Recorded Data

Make sure Communication Cable is connected to the Computer.

Make sure Communication Cable is connected to the Thermo Recorder.

- For instructions on these steps, see page 14.

Begin Downloading Data.

1. From the [Communication] menu select [Download Recorded Data...]
2. The [Download Recorded Data] screen will appear.

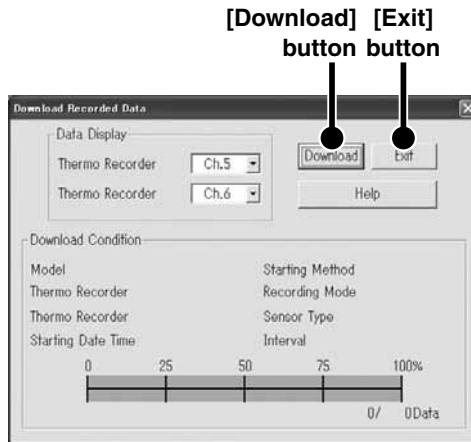

3. Start downloading by clicking [Download]
4. After downloading has been completed click the [Exit] button and the corresponding graph will be displayed.

Temperature Humidity Graph

Screen Names and Functions

- This screen is only a representation for explanation purposes and may differ from actual screen.
- For a detailed explanation of operations use the [Help] menu.

Graph Display

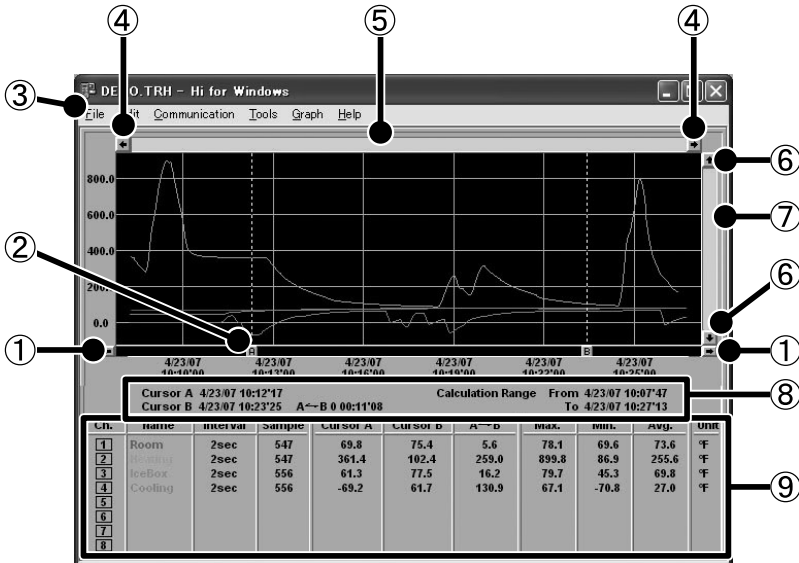

① A and B Cursor Movement Buttons

By clicking the arrow buttons, you can simultaneously move the A/B cursors.

② A and B Cursor Buttons

Click and drag the A or B button to move the cursor to the left or right.

③ Menu Bar

Click on the desired menu in the Menu Bar to set or display each function from which you can choose from an array of commands. They can be used to display or make settings for the various functions for each menu.

④ Button for Moving Horizontal Axis

The time axis moves by clicking these arrow buttons.

⑤ Horizontal Gauge Bar

By dragging the gauge you can move left and right to the data you want to be displayed.

⑥ Button for Moving Vertical Axis

The vertical axis moves up or down by clicking these arrow buttons.

⑦ **Vertical Gauge Bar**

By dragging the gauge you can move up and down to the data you want to be displayed.

⑧ **A and B Cursor Position Information**

The approximate date and time for the A and B cursor positions and the time difference between the A cursor and the B cursor is displayed.

⑨ **Channel Info List Display**

The detailed data info for each channel 1 to 8 is displayed below the Graph Display.

Zoom in Using the Mouse

With the left button drag the mouse to outline the area you want to zoom in on.

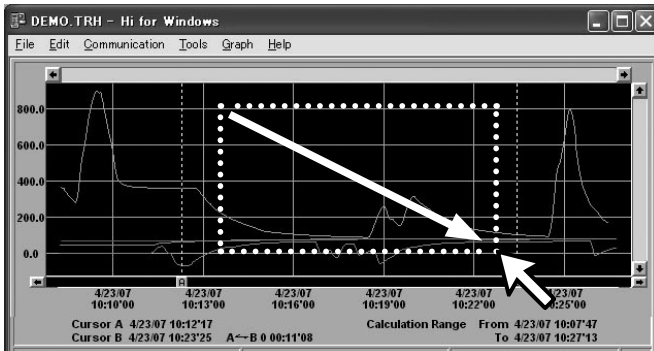

Data List Display

This is a list of the data that was displayed in graph form.

Date Time	Room	Humidity	Ice	Cool	Avg
4/23/2007 10:08:15				46.2	-1.1
4/23/2007 10:08:17	69.6	363.0		46.2	-1.1
4/23/2007 10:08:19	69.6	362.8		46.2	-1.1
4/23/2007 10:08:21	69.6	361.4		46.2	-1.1
4/23/2007 10:08:23	69.6	357.8		46.0	-1.1
4/23/2007 10:08:25	69.8	352.2		46.0	-1.1
4/23/2007 10:08:27	69.8	344.7		46.0	-1.1
4/23/2007 10:08:29	69.8	336.6		46.0	-1.1
4/23/2007 10:08:31	69.6	326.8		46.0	-0.9
4/23/2007 10:08:33	69.6	321.4		46.0	-0.9

Scroll Bar: By dragging it up and down you can move to the data you want.

Maximum Value is in RED, Minimum is in BLUE, and Average is in PINK.

Saving Recorded Data

If you have edited any data that was displayed in a graph, we suggest that you save it as necessary.

3 Ways to Save Files

-In the [File] Menu, select [Overwrite All Data]

Will save any changes to file without changing File Name and Saving Location. The same operation can be carried out from [Save] in the Toolbar.

-In the [File] Menu, select [Save All Data as...]

Save with a new File Name.

-In the [File] Menu, select [Save Displayed Data]

Save only that data in the current display. This is handy when you wish to save only the desired data.

EX: [Save All Data as...]

1. Click [Save All Data as...] in the [File] Menu.
2. Specify the [Location] and enter a [File Name].

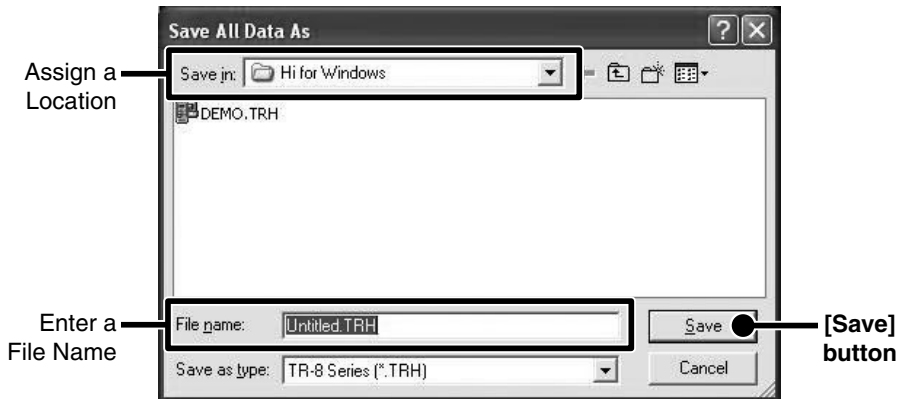

3. Click [Save] to complete the saving process.

Creating Text File

By saving the recorded data as text file, you can create a file type that can be read by common spreadsheet software.

From the [File] Menu select either [Output All Data in Text File...] or [Output Partial Data in Text File...]

EX: [Output All Data in Text File]

1. In the [File] Menu, click [Output All Data in Text File] .
2. **Designate the file name**, the file type to save the data in and the location to which the file should be saved. Then click the [Save] button to create and save the data as a Text File document.

**Comma, Tab, Space, and Semi-colon are codes used by common spreadsheet software, such as Excel®, when reading Text File to divide cells.*

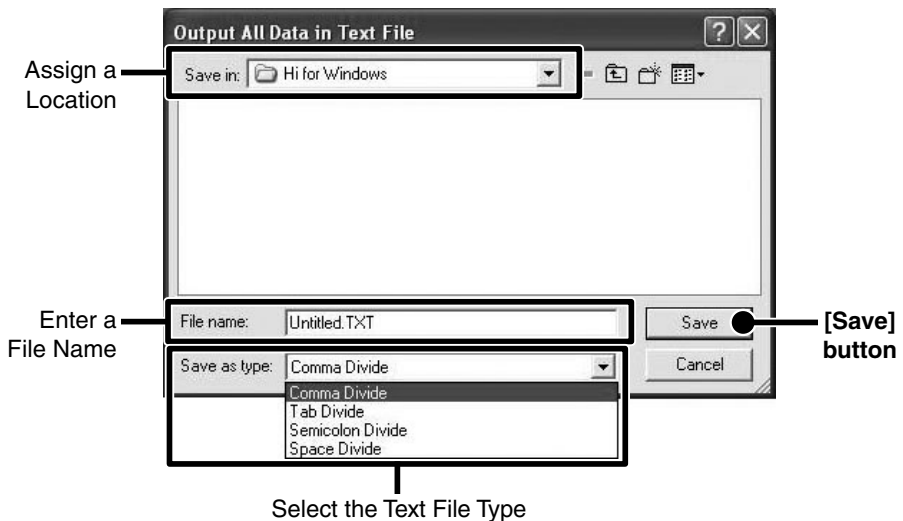

-The extension for the created file will be [.txt].

***Text File can not be loaded into Hi for Windows.**

Troubleshooting

Q: I can not communicate with my computer using serial (RS-232C) communication, what should I do?

A: Please confirm the following items.

Check the Main Unit

- Check to make sure that there is enough battery power and that the power of the main unit is ON.
- Check the connection between the computer and the Unit.
- Check to make sure that the Unit is connected to the Serial Port (RS-232C) and not connected to a different type of communication port (printer or other).
- If you are using a USB-Serial Adaptor, check to make sure that it is a Operational Guaranteed Product

Check your Computer



- Make sure that the serial port settings are correct and that the port has not been rendered unusable by the settings.
- With some computers, especially all-in-one computers the serial port serves as the modem jack.
- Use the Device Manager to check whether the COM port can be used or not.(see p.24)
- If you are using a USB-Serial adaptor cable, use the Device Manager to check that the driver has been properly installed. If the driver is not installed properly, contact the manufacturer of the USB-Serial adaptor cable being used.
- Check to make sure that the serial port has not been rendered unusable by the BIOS setting.
- Sometimes communication will not work if a switch has been added to the serial port (RS-232C) or an extension cable has been added to the communication cable.
- If you have a computer with energy saving function settings, make sure that the serial port has not been turned off.
- If the PC has two serial ports, try connecting the communication cable to the other port and try communicating again.
- Check to see if some other communication software is in use.
- If you have access to another computer, try seeing if communication works with the other computer.

If none of the above is the cause, there may be a malfunction or product failure.



Please contact your local dealer.

* How to check your Communication Port?

In the Device Manager it is possible to check whether the communication port is usable or not.

If Usable:	If Not Usable:
	 <p data-bbox="623 462 1034 487">An "!", an "x" or an "arrow" will appear</p>

If you are using a USB-Serial Adaptor:

If Usable:	If Not Usable:
	 <p data-bbox="623 682 1034 738">Under "Other Devices" an "!", an "x" or an "arrow" will appear.</p>

For details about checking a communication port, see below.

1. Open the [Control panel]-[Device Manager].
2. In the [Device Manager], click on [Port (COM&LPT)] and check to see if under that appears [Com Port (COM1)] or [Com Port (COM2)].
If a port appears, it should be usable.



3. If an "!", an "x" or an "arrow" appears, the port is not usable.



To find out details about any communication port with an "!", an "x" or an "arrow" mark, right click on the port and select [Properties].



Q: I cannot download recorded data, what should I do?

A: Check to make sure that there is stored recorded data in the unit? If there is no recorded data, downloading cannot occur

Check the LCD display of the unit; if there is no data shown to be stored in the unit downloading cannot be carried out.

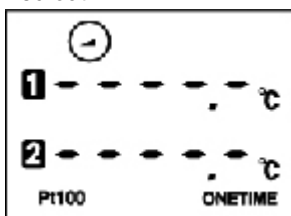

If there is recorded data stored in the unit but data cannot be downloaded please see "Q1: I cannot communicate with my computer using serial (RS-232C) communication, what should I do?"

Q: The images are hanging off the display screen. What should I do ?

A: The display should be set at a resolution of 640x480 dpi or higher.

Q: The date and the time of the recorded data are different from the actual date and time. What should I do?

A: The Thermo Recorder takes the date and time from your computer when it is set up. Make sure that the date and time are correct on your computer.

Q: Is the data backed up automatically?

A: If the battery power goes low while recording the BAT lamp will come on. If the power decreases even more, recording will be ceased and a backup of the recorded data will be made.

Specifications

Thermo Recorder TR-81

Recording Channels	2 Channels
Sensors	Pt100 Sensors (3-wire,4-wire)(*1)
Measurement Range	-200°C to 600°C
Measurement Reliability (when main unit is at 20°C±10°C)	±0.3°C [-200 to 80°C], ±0.5°C [80 to 450°C], ±1.0°C [450 to 600°C] <i>*No account for sensor differences related to sensor type.</i>
Measurement Resolution	0.1°C
Measurement Current	1 mA
Starting Methods	Immediate / Programmed (by computer only)
Recording Modes	One Time / Endless Loop
Recording Intervals	1, 2, 5, 10, 15, 20, 30 seconds, 1, 2, 5, 10, 15, 20, 30, 60 minutes
Battery	1 Lithium CR2 Battery
Battery Life	Maximum 8 months
Display	Temperature and Unit, Recording Settings, Battery Warning, Amount of Data, Sensor Type and Recording Mode.
Data Capacity	8000 Readings x 2 Channels
Dimensions / Weight	H123mm x W58mm x D33mm / 132 grams
Temp. and Humidity Resistance	-10 to 60°C 90%RH (No condensation)

Software (Hi for Windows)

Compatible OS (*2)	Microsoft Windows 10 32/64bit Microsoft Windows 8 32/64bit Microsoft Windows 7 32/64bit Microsoft Windows Vista 32bit (SP1 or later)
Display Languages (*3)	English

*1 In the case of a 4-wire sensor, one wire will be left unused.

*2 For installation, it is necessary to have Administrator (Computer Administrator) rights.

*3 We recommend using an operating system in the same language as the display language. Operation in different languages is not guaranteed.

The specifications listed above are subject to change without notice.

Other Accessories

Communication Cable	1 RS-232C: D-SUB 9pin cable 1.5 meters
Battery	1 Lithium (CR2)
Attachment Plate	1 (includes 1 screw)
User's Manual	1 booklet

For product information or questions contact us at

T&D CORPORATION

Shimadachi 817-1, Matsumoto, Nagano 390-0852 Japan

TEL: +81-263-40-0131

FAX: +81-263-40-3152

Office Hours : Monday to Friday 9:00-12:00 / 13:00-17:00
(GMT+9:00 Tokyo Time)

[T&D Website]

<http://www.tandd.com/>

